

ENGINEERING AND GINNING

First Stage Seed-Cotton Cleaning System PM₁₀ Emission Factors and Rates for Cotton Gins: Method 201A PM₁₀ Sizing Cyclones

Michael D. Buser*, Derek P. Whitelock, J. Clif Boykin, and Gregory A. Holt

ABSTRACT

This report is part of a project to characterize cotton gin emissions from the standpoint of stack sampling. The impetus behind this project was the urgent need to collect additional cotton gin emissions data to address current regulatory issues. A key component of this study was focused on EPA emission factors for particulate matter with a particle diameter nominally less than or equal to 10 μm (PM₁₀). The 1996 EPA AP-42 emission factors were assigned quality ratings, from A (Excellent) to E (Poor), to assess the quality of the data being referenced. Emission factor quality ratings for cotton gins were extremely low. Cotton gin data received these low ratings because they were collected almost exclusively from a single geographical region. The objective of this study was to collect additional PM₁₀ emission factor data for 1st stage seed-cotton cleaning systems at cotton gins located in regions across the cotton belt based on EPA-approved stack sampling methodology, Method 201A. The project plan included sampling seven cotton gins across the cotton belt. Key factors for selecting specific cotton gins included: 1) facility location, 2) production capacity, 3) processing systems and 4) abatement technologies. In terms of capacity, the seven gins were typical of the industry, averaging 31.9 bales/h during testing. Some test runs were excluded from the test averages because they failed to meet EPA Method 201A test criteria. Also, other test runs, included in the analyses, had cotton lint fibers that collected in the ≤ 10 μm samples. This larger lint material can affect the reported

emissions data, but EPA Method 201A does not suggest methods to account for these anomalies. The 1st stage seed-cotton cleaning system average emission factors for PM₁₀ and total particulate were 0.097 kg/227-kg bale (0.215 lb/500-lb bale) and 0.144 kg/bale (0.317 lb/bale), respectively. The system average PM₁₀ emission factor was higher, and the system average total particulate emission factor was lower than those currently published in EPA AP-42. First stage seed-cotton cleaning system PM₁₀ emission rate test averages ranged from 1.61 to 4.72 kg/h (3.55 to 10.40 lb/h). The ratio of 1st stage seed-cotton cleaning system PM₁₀ to total particulate was 67.7%.

U.S. Environmental Protection Agency (EPA) emission factors published in EPA's Compilation of Air Pollution Emission Factors, AP-42 (EPA, 1996b) were assigned a rating that is used to assess the quality of the data being referenced. Ratings can range from A (Excellent) to E (Poor). Current EPA emission factor quality ratings for particulate matter with a particle diameter less than or equal to a nominal 10-μm (PM₁₀) aerodynamic equivalent diameter from cotton gins are extremely low. Cotton gin data received these low ratings because they were collected almost exclusively from a single geographical region (EPA, 1996a). Cotton ginners' associations across the cotton belt, including the National, Texas, Southern, Southeastern, and California associations, agreed that there was an urgent need to collect additional cotton gin emissions data to address current regulatory issues. Working with cotton ginning associations across the country and state and federal regulatory agencies, Oklahoma State University and USDA-Agricultural Research Service (ARS) researchers developed a proposal and sampling plan that was initiated in 2008 to address this need for additional data. This report is part of a series that details cotton gin emissions measured by stack sampling. Each manuscript in the series addresses a specific cotton ginning system. The systems covered in the series include: unloading, 1st stage

M.D. Buser*, Oklahoma State University, Stillwater, OK 74078; D.P. Whitelock, USDA-ARS Southwestern Cotton Ginning Research Laboratory, Mesilla Park, NM 88047; J.C. Boykin, USDA-ARS Cotton Ginning Research Unit, Stoneville, MS 38776; and G.A. Holt, USDA-ARS Cotton Production and Processing Research Unit, Lubbock, TX 79401

*Corresponding author: buser@okstate.edu

seed-cotton cleaning, 2nd stage seed-cotton cleaning, 3rd stage seed-cotton cleaning, overflow, 1st stage lint cleaning, 2nd stage lint cleaning, combined lint cleaning, cyclone robber, 1st stage mote, 2nd stage mote, combined mote, mote cyclone robber, mote cleaner, mote trash, battery condenser and master trash. This report focuses on PM₁₀ emissions from 1st stage seed-cotton cleaning systems.

The 1996 EPA AP-42 average PM₁₀ emission factor for the No. 1 dryer and cleaner, which is an equivalent system to the 1st stage seed-cotton cleaning system, was 0.055 kg (0.12 lb) per 217-kg (480-lb) equivalent bale with a range of 0.039 to 0.096 kg (0.088-0.21 lb) per bale (EPA, 1996a, 1996b). The AP-42 average total particulate emission factor was 0.17 kg (0.36 lb) per bale with a range of 0.11 to 0.25 kg (0.24 to 0.54 lb) per bale. These PM₁₀ and total factors were based on five and seven tests, respectively, and were assigned quality ratings of D, the second lowest possible rating (EPA, 1996a).

Seed cotton is a perishable commodity that has no real value until the fiber and seed are separated (Wakelyn et al., 2005). Cotton must be processed or ginned at the cotton gin to separate the fiber and seed, producing 227-kg (500-lb) bales of marketable cotton fiber. Cotton ginning is considered an agricultural process and an extension of the harvest by several federal and state agencies (Wakelyn et al., 2005). Although the main function of the cotton gin is to remove the lint fiber from the seed, many other processes also occur during ginning, such as cleaning, drying, and packaging the lint. Pneumatic conveying systems are the primary method of material handling in the cotton gin. As material reaches a processing point, the conveying air is separated and emitted outside the gin through a pollution control device. The amount of dust emitted by a system varies with the process and the condition of the material in the process.

Cotton ginning is a seasonal industry with the ginning season lasting from 75 to 120 days, depending on the size and condition of the crop. Although the trend for U.S. cotton production remained generally flat at about 17 million bales per year during the last 20 years, production from one year to the next often varied greatly for various reasons, including climate and market pressure (Fig. 1). The number of active gins in the U.S. has not remained constant, steadily declining to fewer than 700 in 2011. Consequently, the average volume of cotton handled by

each gin has risen and gin capacity has increased to an average of about 25 bales per hour across the U.S. cotton belt (Valco et al., 2003, 2006, 2009, 2012).

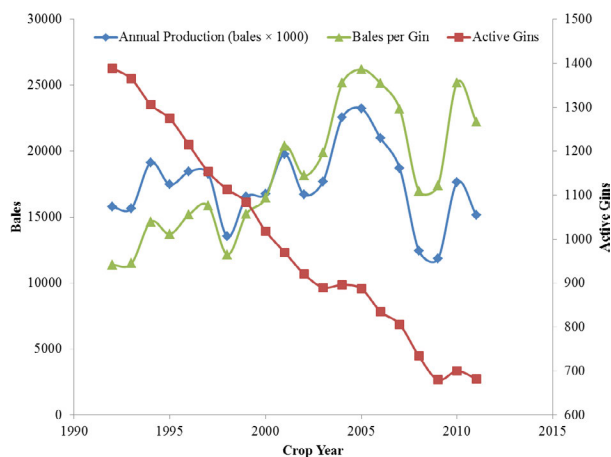

Figure 1. Annual U.S. cotton production, active U.S. gins, and average ginning volume (bales per gin) (NASS, 1993-2012).

Typical cotton gin processing systems include: unloading system, dryers, seed-cotton cleaners, gin stands, overflow collector, lint cleaners, battery condenser, bale packaging system, and trash handling systems (Fig. 2); however, the number and type of machines and processes can vary. Each of these systems serves a unique function with the ultimate goal of ginning the cotton to produce a marketable product. Raw seed cotton harvested from the field is compacted into large units called “modules” for delivery to the gin. The unloading system removes seed cotton either mechanically or pneumatically from the module feed system and conveys the seed cotton to the seed-cotton cleaning systems. Seed-cotton cleaning systems assist with drying the seed cotton and remove foreign matter prior to ginning. Ginning systems also remove foreign matter and separate the cotton fiber from seed. Lint cleaning systems further clean the cotton lint after ginning. The battery condenser and packaging systems combine lint from the lint cleaning systems and compress the lint into dense bales for efficient transport. Cotton gin systems produce some type of by-products or trash, such as rocks, soil, sticks, hulls, leaf material, and short or tangled immature fiber (motes), as a result of processing the seed cotton or lint. These streams of by-products must be removed from the machinery and handled by trash collection systems. These trash systems typically further process the by-products (e.g., mote cleaners) and/or consolidate the trash from the gin systems into a hopper or pile for subsequent removal.

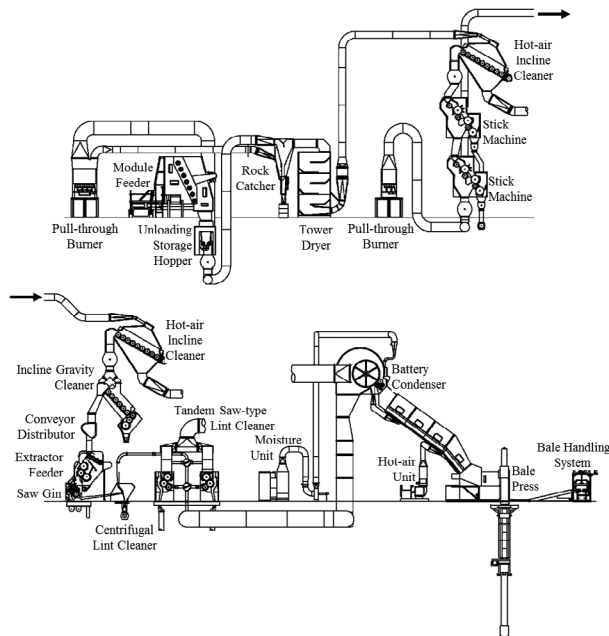

Figure 2. Typical modern cotton gin layout (Courtesy Lummus Corporation, Savannah, GA).

The seed cotton is cleaned and dried in the seed-cotton cleaning systems. In the typical 1st stage seed-cotton cleaning system (Fig. 3), seed cotton is pneumatically conveyed with heated air from either the feed control or module feeder through a dryer to the seed-cotton cleaning machinery. The seed cotton is pulled directly into the seed-cotton cleaning machinery and separated from the conveying airstream by the cleaning mechanism (called a “hot-air” cleaner) or separated from the conveying air via a screened separator and dropped into the cleaning machinery. Seed-cotton cleaning machinery includes cleaners or extractors. Each stage often employs two cleaners in series. This system removes foreign matter that includes rocks, soil, sticks, hulls, and leaf material. The airstream from the 1st stage seed-cotton cleaning system continues through a centrifugal fan to an abatement system; generally one or more cyclones. This cleaning system may use air heated up to 117°C (350°F) at the seed cotton and air mixing point to accomplish drying during transport (ASABE, 2007). Based on system configuration, the airstream temperature at the abatement device could range from ambient to about 50% of the mixing-point temperature. The material handled by the abatement system is typically the same as that removed by the seed-cotton cleaning machinery (rocks, soil, sticks, hulls, and leaf material) and lint extracted with the trash (Fig. 4).

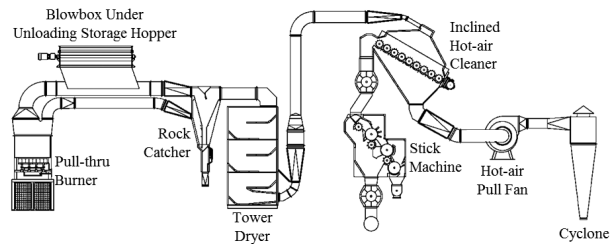

Figure 3. Typical cotton gin 1st stage seed-cotton cleaning system layout (Courtesy Lummus Corporation, Savannah, GA).



Figure 4. Photograph of typical trash captured by the 1st stage seed-cotton cleaning system cyclones.

Cyclones are the most common particulate matter abatement devices used at cotton gins. Standard cyclone designs used at cotton ginning facilities are the 2D2D and 1D3D (Whitelock et al., 2009). The first D in the designation indicates the length of the cyclone barrel relative to the cyclone barrel diameter and the second D indicates the length of the cyclone cone relative to the cyclone barrel diameter. A standard 2D2D cyclone (Fig. 5) has an inlet height of D/2 and width of D/4 and design inlet velocity of 15.2 ± 2 m/s (3000 ± 400 fpm). The standard 1D3D cyclone (Fig. 5) has the same inlet dimensions as the 2D2D or may have the original 1D3D inlet with height of D and width D/8, but has a design inlet velocity of 16.3 ± 2 m/s (3200 ± 400 fpm).

The objective of this study was to collect additional PM₁₀ emission factor data for 1st stage seed-cotton cleaning systems with cyclones for emissions control at cotton gins located in regions across the cotton belt based on EPA-approved stack sampling methodologies.

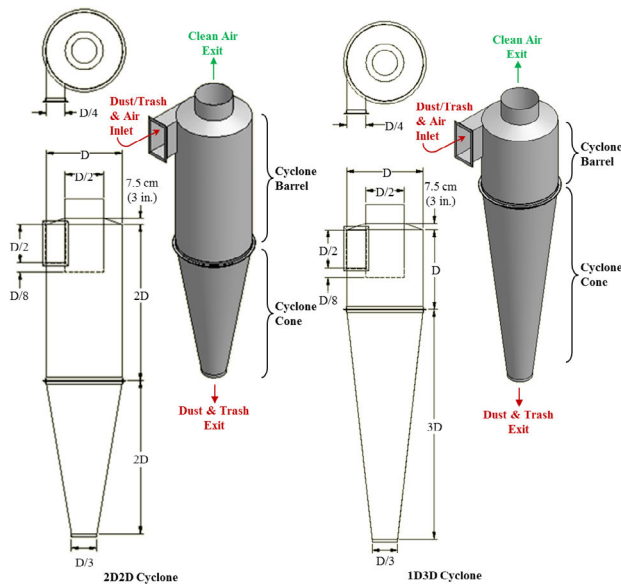

Figure 5. 2D2D and 1D3D cyclone schematics.

METHODS

Two advisory groups were established for this project. The industry group consisted of cotton ginning industry leaders and university and government researchers. The air quality group included members from state and federal regulatory agencies and university and government researchers. These groups were formed to aid in project planning, gin selection, data analysis, and reporting. The project plan was described in detail by Buser et al. (2012).

Seven cotton gins were sampled across the cotton belt. Key factors for selecting specific cotton gins included: 1) facility location, 2) production capacity, 3) processing systems and 4) abatement technologies. Operating permits, site plans, and aerial photographs were reviewed to evaluate potential sites. On-site visits were conducted on all candidate gins to evaluate the process systems and gather information including system condition, layout, capacities, and standard operation. Using this information, several gins from each selected geographical region were selected and prioritized based on industry advisory group discussions. Final gin selection from the prioritized list was influenced by crop limitations and adverse weather events in the region.

Based on air quality advisory group consensus, EPA Method 201A was used to sample the 1st stage seed-cotton cleaning system at each gin. Method 201A was revised in 2010 to incorporate options for PM_{2.5} (particulate matter with particle diameter less than or equal to a nominal 2.5- μ m aerodynamic

equivalent diameter) sampling (CFR, 2010); these revisions did not affect the PM₁₀ stack sampling methodology used in this project. Method 201A is a constant sampling rate procedure. For the PM₁₀ sampling methodology, the particulate-laden stack gas was withdrawn isokinetically (the velocity of the gas entering the sampler was equal to the velocity of the gas in the stack) through a PM₁₀ sizing cyclone and then collected on an in-stack filter (Fig. 6). The methods for retrieving the filter and conducting acetone washes of the sizing cyclone are described in detail in Method 201A (CFR, 2010). The mass of each size fraction was determined by gravimetric analysis and included: > 10 μ m (PM₁₀ sizing cyclone catch acetone wash) and \leq 10 μ m (PM₁₀ sizing cyclone exit acetone wash and filter). The PM₁₀ mass was determined by adding the mass of particulates captured on the filter and the \leq 10 μ m wash. Total particulate was determined by adding the PM₁₀ mass and the mass of the > 10 μ m wash.

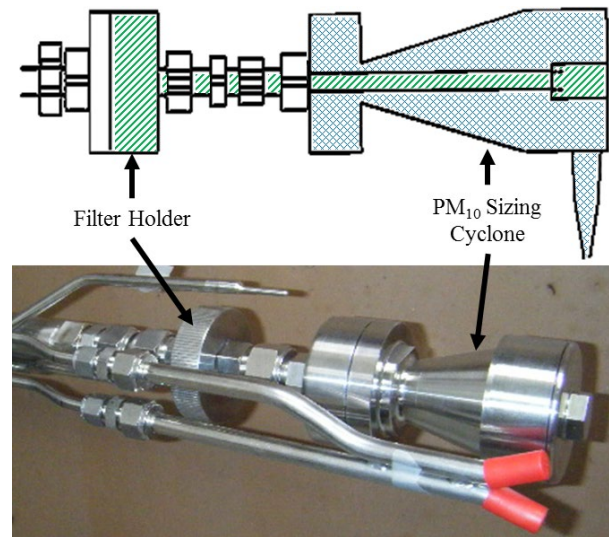

Figure 6. EPA Method 201A PM₁₀ sizing cyclone and in-stack filter holder schematic (CFR, 2010) and photograph (// \leq 10 μ m, // $>$ 10 μ m).

Figure 7 shows the performance curves for the Method 201A sizing cyclones. To measure PM₁₀, the method requires selecting a gas sampling nozzle to achieve a sampling rate that produces a cut size between 9.0 and 11.0 μ m at the stack gas temperature. For this study, Method 201A was specifically used to collect filterable PM₁₀ emissions (solid particles emitted by a source at the stack and captured in the \leq 10 μ m wash and on the filter [CFR, 2010]). Only one stack from each stage seed-cotton cleaning system was tested. For systems with multiple stacks, it was assumed that emissions from each stack of the

system were equivalent and the total emissions were calculated by multiplying the measured emission rates by the total number of cyclones used to control the process tested (EPA, 1996a). To obtain reliable results, the same technician from the same certified stack sampling company (Reliable Emissions Measurements, Auberry, CA), trained and experienced in stack sampling cotton gins, conducted the tests at all seven cotton gins.

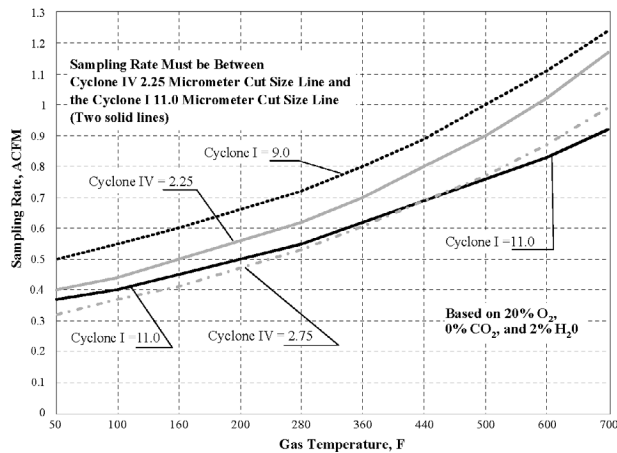

Figure 7. Acceptable sampling rate for sizing cyclones (CFR, 2010) Cyclone I = PM₁₀ sizing cyclone (Gas temperatures for the stage seed cotton cleaning systems tested ranged from 23 to 73°C [73-163°F]).

All stack sampling equipment, including the sizing cyclone, was purchased from Apex Instruments (Fuquay-Varina, NC) and met specifications of Method 201A. The sampling media were 47 μm Zefluor filters (Pall Corporation, Port Washington, NY) and the sample recovery and analytical reagent was American Chemical Society certified acetone (A18-4, Fisher Chemical, Pittsburgh, PA – assay ≥ 99.5%). Filters and wash tubs and lids were pre-labeled, pre-weighed, and stored in sealed containers at the USDA-ARS Air Quality Lab (AQL) in Lubbock, TX, and then transported to each test site. Prior to testing, the certified stack testing technician calibrated and checked all sampling equipment according to EPA Method 201A.

Each cyclone selected for testing was fitted with a cyclone stack extension that incorporated two sampling ports (90° apart) and airflow straightening vanes to eliminate the cyclonic flow of the air exiting the cyclone (Fig. 8). The extensions were designed to meet EPA criteria (EPA, 1989) with an overall length of 3 m (10 ft) and sampling ports 1.2-m (48-in) downstream from the straightening vanes and 0.9-m (36-in.) upstream from the extension exit.



Figure 8. Schematic and photographs of stack extensions with sampling ports and straightening vanes (rail attached to extension above sampling port, at right, supports sampling probe during testing traverse).

The tests were conducted by the certified stack sampling technician in an enclosed sampling trailer at the base of the cyclone bank (Fig. 9). Sample retrieval, including filters and sampler head acetone washes, was conducted according to Method 201A. After retrieval, filters were sealed in individual Petri dishes and acetone washes were dried on-site in a conduction oven at 49°C (120°F) and then sealed with pre-weighed lids and placed in individual plastic bags for transport to the AQL in Lubbock, TX for gravimetric analyses. During testing, bale data (ID number, weight, and date/time of bale pressing) were either manually recorded by the bale press operator or captured electronically by the gin’s computer system for use in calculating emission factors in terms of kg/227-kg bale (lb/500-lb bale). Emission factors and rates were calculated in accordance with Method 201A and ASAE Standard S582 (ASABE, 2005).

All laboratory analyses were conducted at the AQL. All filters were conditioned in an environmental chamber (21 ± 2°C [70 ± 3.6°F]; 35 ± 5% RH) for 48 h prior to gravimetric analyses. Filters were weighed in the environmental chamber on a Mettler MX-5 microbalance (Mettler-Toledo Inc., Columbus,

OH – 1 µg readability and 0.9 µg repeatability) after being passed through an anti-static device. The MX-5 microbalance was leveled on a marble table and housed inside an acrylic box to minimize the effects of air currents and vibrations. To reduce recording errors, weights were electronically transferred from the microbalance directly to a spreadsheet. Technicians wore latex gloves and a particulate respirator mask to avoid contamination. AQL procedures required that each sample be weighed three times. If the standard deviation of the weights for a given sample exceeded 10 µg, the sample was reweighed. Gravimetric procedures for the acetone wash tubs were the same as those used for filters.

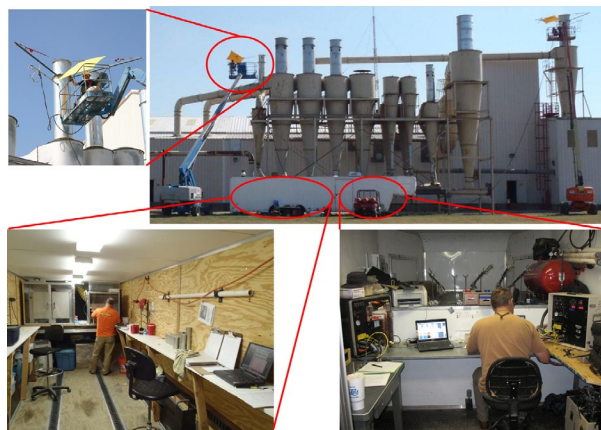

Figure 9. Clockwise from top right: cotton gin stack sampling with air quality lab trailer and technicians on lifts; certified stack sampling technician in the trailer control room conducting tests; sample recovery in trailer clean room; technician operating the probe at stack level.

In addition to gravimetric analyses, each sample was visually inspected for unusual characteristics, such as cotton lint content or extraneous material. Digital pictures were taken of all filters and washes for documentation purposes prior to further analyses. After the laboratory analyses were completed all stack sampling, cotton gin production, and laboratory data were merged.

All seven gins had stage seed cotton cleaning systems. The 1st stage seed-cotton cleaning systems sampled were typical for the industry. Gins B, E, and G had similar 1st stage seed-cotton cleaning systems (Fig. 10). The seed-cotton material was pneumatically conveyed from the module feeder to a series of seed-cotton cleaners. The material was separated from the airstream by the first cleaner. The air then passed through a fan and exhausted through one or more cyclones. The gin A system used a feed control unit to regulate the flow of

seed cotton (Fig. 11). The material was conveyed pneumatically from the feed control unit through a dryer then the material stream was split. The air was separated from each stream by the first set of parallel cleaners. The two airstreams then merged and passed through a fan and exhausted through one or more cyclones. The 1st stage seed-cotton cleaning systems at gins D and F were similar to the systems at gins B, E, and G except the material stream was split into two parallel systems after the feed control or module feeder (Fig. 12). The 1st stage seed-cotton cleaning system for gin C was similar to the system at gin F except there were separate feed control units for the parallel systems (Fig. 13).

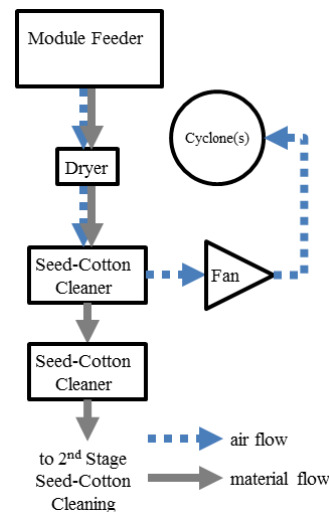

Figure 10. Schematic of single stream/single fan 1st stage seed-cotton cleaning system fed directly by a module feeder (gins B, E, and G).

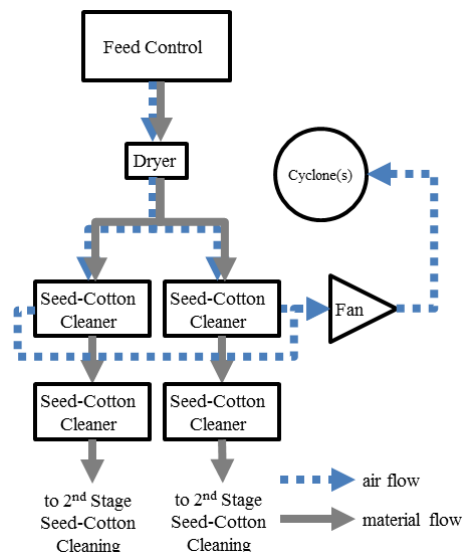

Figure 11. Schematic of split stream/single fan 1st stage seed-cotton cleaning system fed by a feed control (gin A).

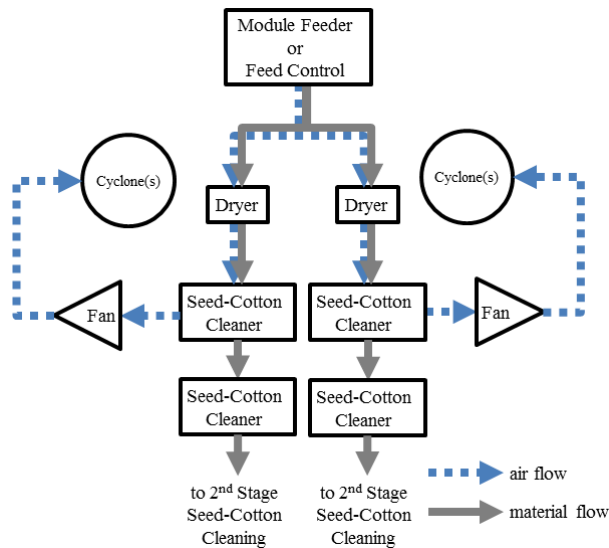

Figure 12. Schematic of split stream/double fan 1st stage seed-cotton cleaning system fed by a feed control (gin D) or fed directly by a module feeder (gin F).

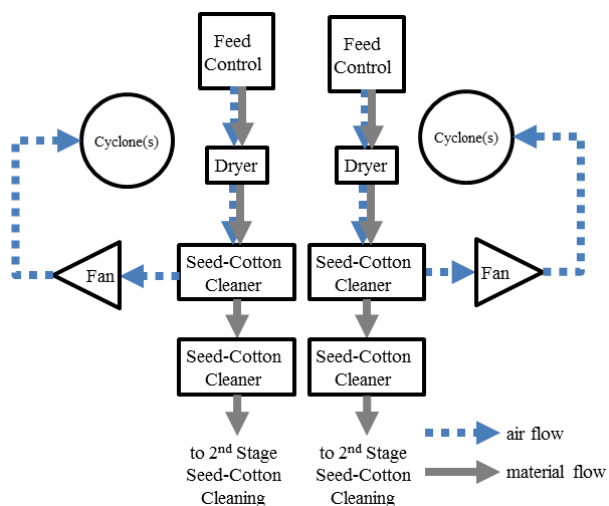

Figure 13. Schematic of completely separate systems split stream/double fan 1st stage seed-cotton cleaning system fed by a feed control (gin C).

All 1st stage seed-cotton cleaning systems sampled utilized 1D3D cyclones to control emissions (Fig. 5), but there were some cyclone design variations among the gins (Table 1 and Fig. 14). All the gins, except gin E, split the system exhaust flow between two cyclones in a dual configuration (side-by-side as opposed to one-behind-another). The system airstream for gin E was exhausted through a single cyclone. Inlets on all the 1st stage seed-cotton cleaning cyclones were 2D2D type, except gin C that had inverted 1D3D inlets. Expansion chambers were present on 1st stage seed-cotton cleaning cyclones at all gins, except gins E and F, which had standard cones. All of the cyclone configurations outlined above, if properly designed and maintained, are recommended for controlling cotton gin emissions (Whitelock et al., 2009). The cyclones at gin F had angle-iron welded inside and down the length of the cone (Fig. 15). This is occasionally done by cyclone manufacturers for systems with high particulate loading, especially sand, to encourage material to exit the cyclone more quickly and reduce cone wear; this is not a recommended practice.



Figure 14. Cyclone design variations for the tested systems (left to right): dual configuration that splits flow between identical 1D3D cyclones with 2D2D inlets; 1D3D cyclone with an inverted 1D3D inlet; 1D3D cyclone with 2D2D inlet and expansion chamber on the cone; 1D3D cyclone with 2D2D inlet and standard cone.

Table 1. Abatement device configuration^z for 1st stage seed-cotton cleaning systems tested.

Gin	Cyclone Type	Inlet Design ^y	Systems per Gin	Cyclones per Gin	Configuration	Cone Design	Trash Exits to ^x
A	1D3D	2D2D	1	2	Dual	expansion chamber	hopper
B	1D3D	2D2D	1	2	Dual	expansion chamber	auger
C	1D3D	Inverted 1D3D	2	4	Dual	expansion chamber	hopper
D	1D3D	2D2D	2	4	Dual	expansion chamber	hopper
E	1D3D	2D2D	1	1	Single	standard	auger
F	1D3D	2D2D	2	4	Dual	standard	auger
G	1D3D	2D2D	1	2	Dual	expansion chamber	auger

^z Figures 5 and 14

^y Inverted 1D3D inlet has duct in line with the bottom of the inlet

^x Systems to remove material from cyclone trash exits: hopper = large storage container directly under cyclone trash exit; auger = enclosed, screw-type conveyor



Figure 15. Angle-iron welded to the inside surface of cyclone cone at gin F.

RESULTS

Table 2 shows the test parameters for each Method 201A test run for the 1st stage seed-cotton cleaning systems sampled at the seven gins. The system average ginning rate was 31.9 bales/h and the test average ginning rates at each gin ranged from 23.5 to 40.1 bales/h (based on 227-kg [500-lb] equivalent bales). The capacity of gins sampled was representative of the industry average, approximately 25 bales/h. The 1D3D cyclones were all operated with inlet velocities within design criteria, 16.3 ± 2 m/s (3200 ± 400 fpm), except the test runs at gin C and E and two runs at gin

A that were outside the design range due to limitations in available system adjustments.

There are criteria specified in EPA Method 201A for test runs to be valid for PM₁₀ or total particulate measurements (CFR, 2010). Isokinetic sampling and PM₁₀ aerodynamic cut size must fall within EPA defined ranges ($100 \pm 20\%$ and 10.0 ± 1.0 μm , respectively) for valid PM₁₀ test runs. All tests met both criteria (Table 2). To use the method to also obtain total filterable particulate, sampling must be within 90 to 110% of isokinetic flow. This criterion was not met in the first test run for gin B; thus the data associated with this run were omitted from the total particulate test averages. Sampling rates ranged from 12.2 to 15.6 standard l/min (0.429-0.550 standard ft³/min). The stack gas temperatures ranged from 23 to 73°C (73-163°F).

PM₁₀ emissions data (ginning and emission rates and corresponding emission factors) for the 1st stage seed-cotton cleaning system are shown in Table 3. The system average PM₁₀ emission factor was 0.097 kg/bale (0.215 lb/bale). The test average emission factors ranged from 0.045 to 0.132 kg (0.099-0.291 lb) per bale and emission rates ranged from 1.61 to 4.72 kg/h (3.55-10.40 lb/h). Total particulate emissions data (ginning and emission rates and corresponding emission factors) for the 1st stage seed-cotton cleaning system are shown in Table 4. The system average total particulate emission factor was 0.144 kg/bale (0.317 lb/bale). The test average emission factors ranged from 0.061 to 0.199 kg (0.134-0.439 lb) per bale. The test average total particulate emission rates ranged from 2.18 to 7.31 kg/h (4.81-16.12 lb/h). The ratio of PM₁₀ to total particulate was 67.7% (ratios calculated using tables 3 and 4 may vary slightly from those listed due to rounding).

The average 1st stage seed-cotton cleaning system total particulate emission factor for this project was about 88% of the EPA AP-42 published value for the No. 1 dryer and cleaner (EPA, 1996a, 1996b), which is an equivalent system to the 1st stage seed-cotton cleaning system. The range of test average total particulate emission factors determined for this project and the range of AP-42 emission factor data overlapped. The average 1st stage seed-cotton cleaning system PM₁₀ emission factor for this project was 1.79 times the EPA AP-42 published value for the No. 1 dryer and cleaner. The test average PM₁₀ emission factor range also overlapped with AP-42 emission factor data range.

Table 2. Cotton gin production data and stack sampling performance metrics for the 1st stage seed-cotton cleaning systems.

Gin	Test Run	Ginning Rate, bales/h ^z	Cyclone Inlet Velocity,		Isokinetic Sampling, %	Aerodynamic Cut Size D ₅₀ , PM ₁₀ μm	Sampling Rate ^y		Stack Temperature	
			m/s	fpm			slpm	scfm	°C	°F
A	1	23.9	18.5	3651	92	10.3	12.6	0.444	23	73
	2	26.3	17.7	3482	93	10.6	12.2	0.429	23	73
	3	20.3	18.4	3630	94	10.3	12.7	0.448	23	73
Test Average (n=3)		23.5	18.2	3587						
B	1	24.6	17.2	3390	113 ^x	9.6	14.3	0.504	43	110
	2	25.3	17.5	3453	106	9.8	13.7	0.484	43	109
	3	26.1	17.2	3396	110	9.7	13.9	0.491	42	107
Test Average (n=3)		25.3	17.4	3413						
C	1	22.3	13.8	2707	100	9.8	14.4	0.508	58	136
	2	23.8	13.4	2637	102	9.7	14.3	0.507	56	133
	3	26.9	13.8	2721	96	10.0	14.0	0.493	58	136
Test Average (n=3)		24.3	13.6	2689						
D	1	35.5	16.6	3263	105	10.0	13.5	0.476	47	116
	2	35.4	16.5	3257	105	10.1	13.4	0.474	48	118
	3	36.8	16.5	3247	108	9.8	13.8	0.488	46	114
Test Average (n=3)		35.9	16.5	3255						
E	1	37.1	18.9	3726	104	9.6	14.5	0.513	52	126
	2	33.6	19.4	3823	99	9.8	14.2	0.502	53	127
	3	36.6	19.2	3774	101	9.8	14.2	0.503	54	130
Test Average (n=3)		35.7	19.2	3774						
F	1	45.2	17.8	3506	93	9.8	15.6	0.549	73	163
	2	35.8	17.6	3461	95	9.6	15.6	0.550	67	153
	3	39.2	16.9	3322	94	9.9	14.8	0.524	64	147
Test Average (n=3)		40.1	17.4	3430						
G	1	38.2	16.8	3299	99	10.3	12.9	0.456	45	113
	2	37.3	16.7	3292	104	10.0	13.5	0.478	47	117
	3	40.0	16.7	3288	100	10.6	13.0	0.458	44	112
Test Average (n=3)		38.5	16.7	3293						
System Average (n=7)		31.9	17.0	3349						

^z 227 kg (500 lb) equivalent bales^y slpm = standard l/min, scfm = standard ft³/min^x Did not meet total particulate isokinetic sampling rate criteria (100 ± 10%)

Figure 16 shows an example of samples recovered from a typical 1st stage seed-cotton cleaning system test run. Often, there were cotton lint fibers, which have cross-sectional diameters much greater than 10 μm, in the cotton gin cyclone exhausts. Therefore, it was not unusual to find lint fiber in the > 10 μm wash from Method 201A. However, in the samples shown in Fig. 17, lint fibers passed

through the PM₁₀ cyclone and collected in the ≤ 10 μm wash and on the filter. This type of material carryover can bias the gravimetric measurements and affect reported PM₁₀ emission data. EPA Method 201A does not suggest methods to account for these anomalies. Thus, no effort was made to adjust the data reported in this manuscript to account for these issues.

Table 3. PM₁₀ emissions data for the 1st stage seed-cotton cleaning system.

Gin	Test Run	Emission Rate,		Emission Factor,	
		kg/h	lb/h	kg/bale ^z	lb/bale ^z
A	1	3.60	7.95	0.151	0.333
	2	2.09	4.61	0.079	0.175
	3	2.41	5.32	0.119	0.262
Test Average (n=3)		2.70	5.96	0.116	0.257
B	1	1.48	3.26	0.060	0.133
	2	0.77	1.69	0.030	0.067
	3	2.99	6.59	0.115	0.253
Test Average (n=3)		1.75	3.85	0.068	0.151
C	1	2.28	5.02	0.102	0.225
	2	2.29	5.05	0.096	0.212
	3	2.56	5.64	0.095	0.210
Test Average (n=3)		2.38	5.24	0.098	0.216
D	1	1.00	2.19	0.028	0.062
	2	1.69	3.73	0.048	0.106
	3	2.15	4.74	0.058	0.129
Test Average (n=3)		1.61	3.55	0.045	0.099
E	1	4.40	9.70	0.119	0.262
	2	4.46	9.84	0.133	0.293
	3	5.30	11.68	0.145	0.319
Test Average (n=3)		4.72	10.40	0.132	0.291
F	1	3.44	7.58	0.076	0.168
	2	3.50	7.71	0.098	0.215
	3	4.90	10.81	0.125	0.276
Test Average (n=3)		3.94	8.70	0.100	0.219
G	1	3.59	7.90	0.094	0.207
	2	5.77	12.73	0.155	0.341
	3	4.71	10.38	0.118	0.259
Test Average (n=3)		4.69	10.34	0.122	0.269
System Average (n=7)				0.097	0.215

^z 227 kg (500 lb) equivalent bales

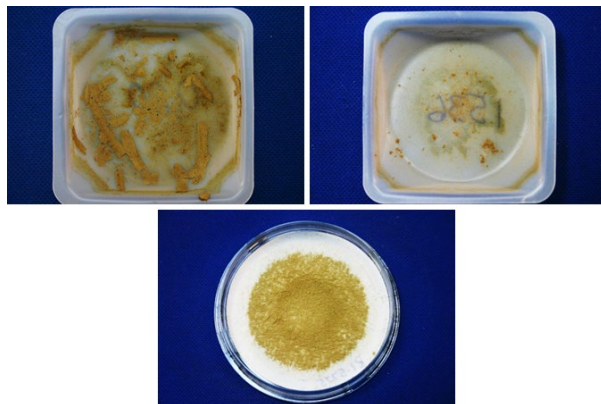

Figure 16. Typical EPA Method 201A filter and sampler head acetone washes from the 1st stage seed-cotton cleaning. Clockwise from top left: > 10 μm wash, ≤ 10 μm wash and filter.

Table 4. Total particulate emissions data for the 1st stage seed-cotton cleaning systems.

Gin	Test Run	Emission Rate,		Emission Factor,	
		kg/h	lb/h	kg/bale ^z	lb/bale ^z
A	1	4.62	10.19	0.194	0.427
	2	3.48	7.68	0.132	0.292
	3	3.13	6.89	0.154	0.339
Test Average (n=3)		3.74	8.25	0.160	0.353
B	1 ^y	1.84	4.06	0.075	0.165
	2	1.16	2.55	0.046	0.101
	3	3.43	7.56	0.131	0.289
Test Average (n=2)		2.29	5.05	0.089	0.195
C	1	3.22	7.10	0.144	0.318
	2	3.63	8.00	0.152	0.336
	3	3.80	8.37	0.141	0.311
Test Average (n=3)		3.55	7.82	0.146	0.322
D	1	1.44	3.18	0.041	0.089
	2	2.33	5.14	0.066	0.145
	3	2.77	6.10	0.075	0.166
Test Average (n=3)		2.18	4.81	0.061	0.134
E	1	6.43	14.17	0.173	0.382
	2	7.04	15.52	0.210	0.462
	3	7.84	17.29	0.214	0.473
Test Average (n=3)		7.10	15.66	0.199	0.439
F	1	7.47	16.47	0.165	0.364
	2	5.83	12.84	0.163	0.358
	3	8.64	19.05	0.220	0.486
Test Average (n=3)		7.31	16.12	0.183	0.403
G	1	5.38	11.86	0.141	0.311
	2	7.50	16.54	0.201	0.443
	3	6.59	14.52	0.165	0.363
Test Average (n=3)		6.49	14.31	0.169	0.372
System Average (n=7)				0.144	0.317

^z 227 kg (500 lb) equivalent bales

^y Test run omitted from test averages because isokinetic sampling rate (100 ± 10%) was not met

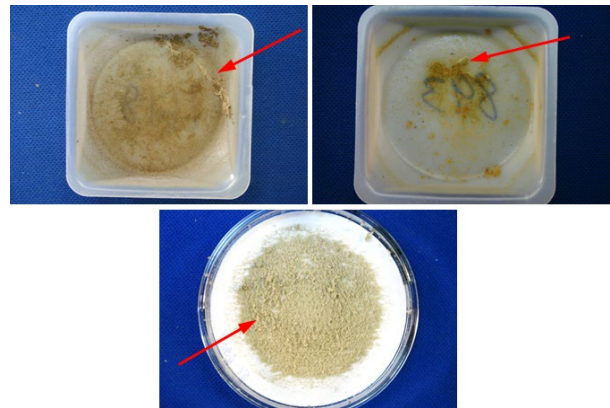

Figure 17. EPA Method 201A filter and sampler head acetone washes from the 1st stage seed-cotton cleaning with lint fibers in the washes and on the filter (indicated by arrows). Clockwise from top left: > 10 μm wash, ≤ 10 μm wash and filter.

SUMMARY

Seven cotton gins across the U.S. cotton belt were sampled using EPA Method 201A to collect additional data to improve the EPA AP-42 PM₁₀ emission factor quality ratings for cotton gins. The seven 1st stage seed-cotton cleaning systems tested were similar in design and typical of the ginning industry. All the systems were equipped with 1D3D cyclones for emissions control with some slight variations in inlet and cone design. In terms of capacity, the seven gins were typical of the industry, averaging 31.9 bales/h during testing. Some test runs were excluded from the test averages because they failed to meet EPA Method 201A test criteria. Also, other test runs, included in the analyses, had cotton lint fibers that collected in the $\leq 10 \mu\text{m}$ samples. This larger lint material can affect the reported emissions data, but EPA Method 201A does not suggest methods to account for these anomalies. The 1st stage seed-cotton cleaning system average emission factors for PM₁₀ and total particulate were 0.097 kg/227-kg bale (0.215 lb/500-lb bale) and 0.144 kg/bale (0.317 lb/bale), respectively. The system average PM₁₀ emission factor was higher and the system average total particulate emission factor was lower than those currently published in EPA AP-42. Gin test average PM₁₀ and total particulate emission rates ranged from 1.61 to 4.72 kg/h (3.55 to 10.40 lb/h) and 2.18 to 7.31 kg/h (4.81 to 16.12 lb/h), respectively. Based on the 1st stage seed-cotton cleaning system emission factors, the ratio of PM₁₀ to total particulate was 67.7%.

ACKNOWLEDGEMENT

The authors appreciate the cooperating gin managers and personnel who generously allowed and endured sampling at their gins. In addition, we thank California Cotton Ginners' and Growers' Association, Cotton Incorporated, San Joaquin Valleywide Air Pollution Study Agency, Southeastern Cotton Ginners' Association, Southern Cotton Ginners' Association, Texas Cotton Ginners' Association, Texas State Support Committee, and The Cotton Foundation for funding this project. The authors also thank the Cotton Gin Advisory Group and Air Quality Advisory Group for their involvement and participation in planning, execution, and data analyses for this project that is essential to developing quality data that will be used by industry, regulatory agencies, and the scientific community. The advisory groups included:

the funding agencies listed above, California Air Resources Board, Missouri Department of Natural Resources, National Cotton Council, National Cotton Ginners' Association, North Carolina Department of Environment and Natural Resources, San Joaquin Valley Air Pollution Control District, Texas A&M University, Texas Commission on Environmental Quality, USDA-NRCS National Air Quality and Atmospheric Change, and U.S. Environmental Protection Agency (national, Region 4 and 9).

DISCLAIMER

Mention of trade names or commercial products in this publication is solely for the purpose of providing specific information and does not imply recommendation or endorsement by the Oklahoma State University or U.S. Department of Agriculture. Oklahoma State University and USDA are equal opportunity providers and employers.

REFERENCES

- American Society of Agricultural and Biological Engineers (ASABE). 2005. Cotton Gins – Method of Utilizing Emission Factors in Determining Emission Parameters. ASAE S582 March 2005. American Society of Agricultural and Biological Engineers, St. Joseph, MI.
- American Society of Agricultural and Biological Engineers (ASABE). 2007. Temperature Sensor Locations for Seed-Cotton Drying Systems. ASAE S530.1 August 2007. American Society of Agricultural and Biological Engineers, St. Joseph, MI.
- Buser, M.D., D.P. Whitelock, J.C. Boykin, and G.A. Holt. 2012. Characterization of cotton gin particulate matter emissions—Project plan. *J. Cotton Sci.* 16:105–116.
- Code of Federal Regulations (CFR). 2010. Method 201A – Determination of PM₁₀ and PM_{2.5} emissions from stationary sources (Constant sampling rate procedure). 40 CFR 51 Appendix M. Available at <http://www.epa.gov/ttn/emc/promgate/m-201a.pdf> (verified 2 Jan. 2013).
- Environmental Protection Agency (EPA). 1989. Particulate sampling in cyclonic flow. U.S. Environmental Protection Agency, Washington, DC. Available online at <http://www.epa.gov/ttn/emc/guidlnd/gd-008.pdf> (verified 2 Jan. 2013).
- Environmental Protection Agency (EPA). 1996a. Emission factor documentation for AP-42, Section 9.7, Cotton Ginning, (EPA Contract No. 68-D2-0159; MRI Project No. 4603-01, Apr. 1996).

Environmental Protection Agency (EPA). 1996b. Food and agricultural industries: Cotton gins. *In* Compilation of air pollution emission factors, Volume 1: Stationary point and area sources. Publ. AP-42. U.S. Environmental Protection Agency, Washington, DC.

National Agricultural Statistics Service (NASS). 1993-2012. Cotton Ginnings Annual Summary [Online]. USDA National Agricultural Statistics Service, Washington, DC. Available at <http://usda.mannlib.cornell.edu/MannUsda/viewDocumentInfo.do?documentID=1042> (verified 2 Jan. 2013).

Valco, T.D., H. Ashley, J.K. Green, D.S. Findley, T.L. Price, J.M. Fannin, and R.A. Isom. 2012. The cost of ginning cotton – 2010 survey results. p. 616–619 *In* Proc. Beltwide Cotton Conference., Orlando, FL 3-6 Jan. 2012. Natl. Cotton Counc. Am., Memphis, TN.

Valco, T.D., B. Collins, D.S. Findley, J.K. Green, L. Todd, R.A. Isom, and M.H. Wilcutt. 2003. The cost of ginning cotton – 2001 survey results. p. 662–670 *In* Proc. Beltwide Cotton Conference., Nashville, TN 6-10 Jan. 2003. Natl. Cotton Counc. Am., Memphis, TN.

Valco, T.D., J.K. Green, R.A. Isom, D.S. Findley, T.L. Price, and H. Ashley. 2009. The cost of ginning cotton – 2007 survey results. p. 540–545 *In* Proc. Beltwide Cotton Conference., San Antonio, TX 5-8 Jan. 2009. Natl. Cotton Counc. Am., Memphis, TN.

Valco, T.D., J.K. Green, T.L. Price, R.A. Isom, and D.S. Findley. 2006. Cost of ginning cotton – 2004 survey results. p. 618–626 *In* Proc. Beltwide Cotton Conference., San Antonio, TX 3-6 Jan. 2006. Natl. Cotton Counc. Am., Memphis, TN.

Wakelyn, P.J., D.W. Thompson, B.M. Norman, C.B. Nevius, and D.S. Findley. 2005. Why Cotton Ginning is Considered Agriculture. *Cotton Gin and Oil Mill Press* 106(8), 5-9.

Whitelock, D.P., C.B. Armijo, M.D. Buser, and S.E. Hughs. 2009. Using cyclones effectively at cotton gins. *Appl. Eng. Ag.* 25:563–576.